

CHARGE ASYMMETRY in TOP PRODUCTION: STANDARD MODEL PREDICTIONS



J. H. Kühn



J.K., G. Rodrigo: PRL 81, 49 (1998)

J.K., G. Rodrigo: PRD 59, 054017 (1999)

O. Antuñano, J.K., G. Rodrigo: PRD 77, 014003 (2008)

J.K., G. Rodrigo: JHEP 1201, (2012) 063

I. Motivation and Main Idea

II. Results at Partonic Level

III. Asymmetries at Tevatron and LHC

I MOTIVATION and MAIN IDEA

dominant process for $t\bar{t}$ production at Tevatron

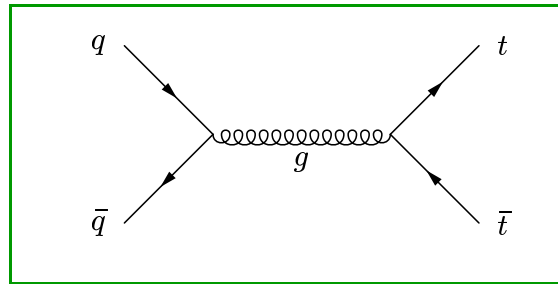

... is symmetric:

$$\frac{d\sigma}{d\cos\hat{\Theta}} \propto \left(1 + \frac{4m^2}{Q^2}\right) + \left(1 - \frac{4m^2}{Q^2}\right) \cos^2\hat{\Theta}$$

$\mathcal{O}(\alpha_s)$ corrections: virtual gluons

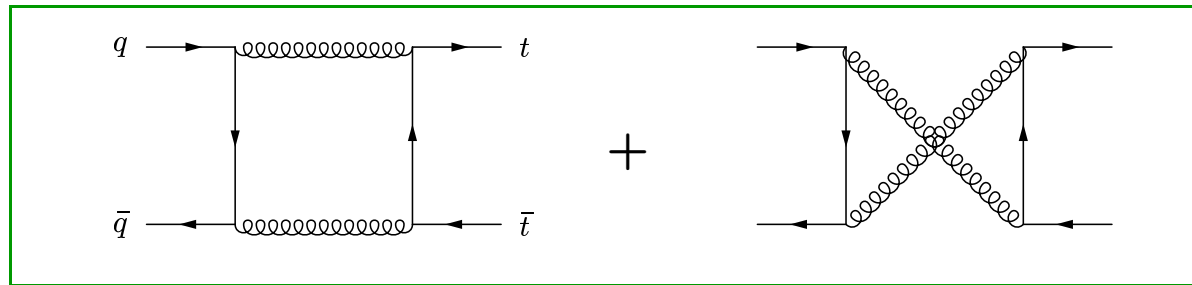

real emission

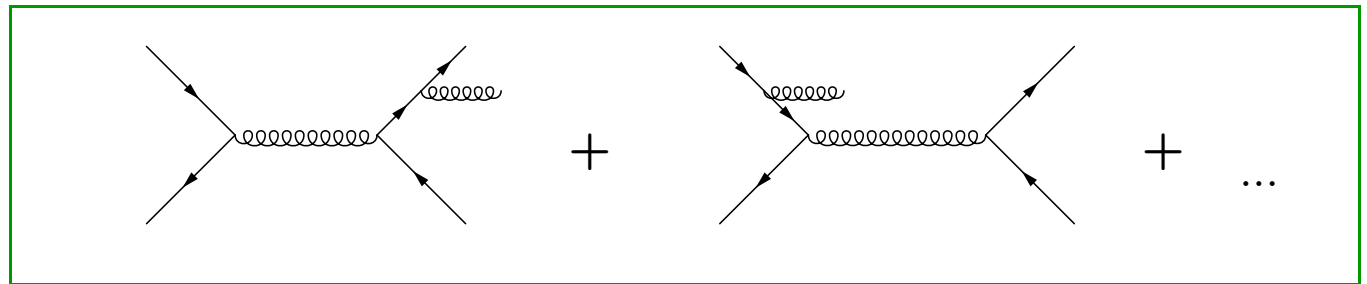

Interference between
 $C = +1$ and $C = -1$
 amplitudes

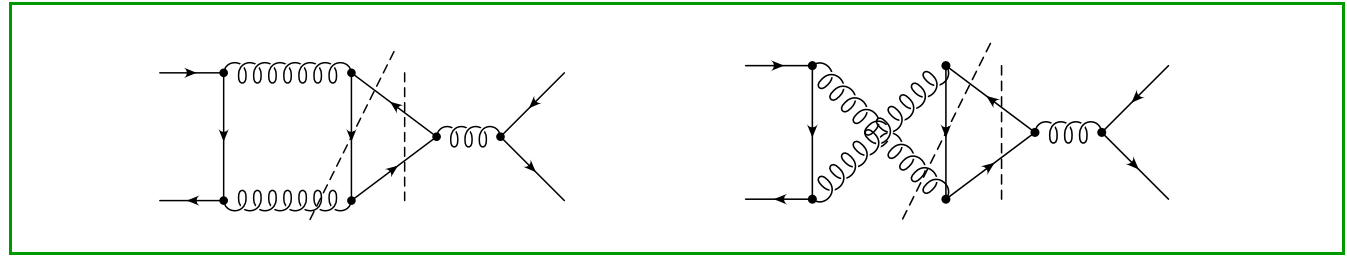

⇒ charge asymmetry
 similar to QED!

$$d\sigma(q\bar{q} \rightarrow QX) - d\sigma(q\bar{q} \rightarrow \bar{Q}X) \neq 0$$

Nonabelian terms:

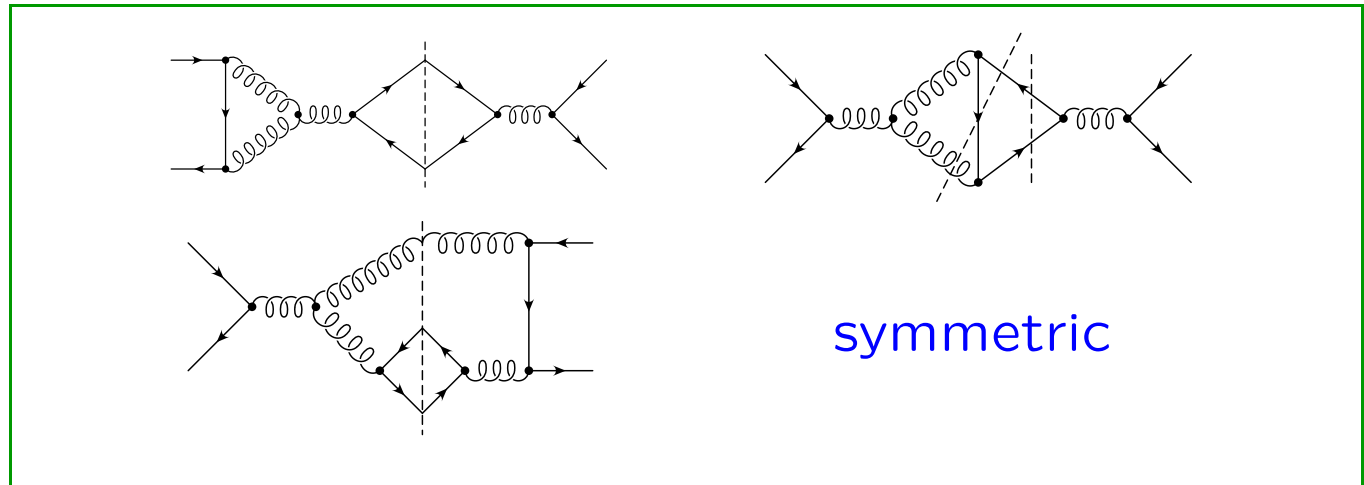

similarly (“flavour excitation”)
 numerically unimportant

$$d\sigma(qg \rightarrow QX) - d\sigma(qg \rightarrow \bar{Q}X) \neq 0$$

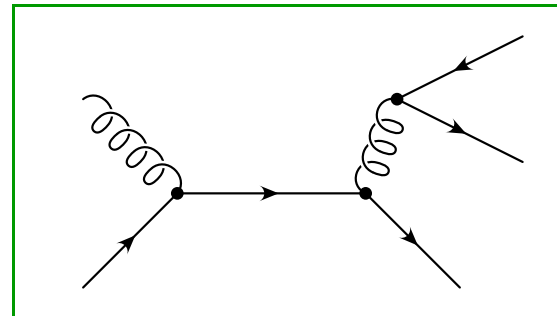

real and virtual corrections must be combined to obtain sensible (=IR-finite) result

⇒ forward-backward asymmetry of top quarks in $p\bar{p}$ collisions (TEVATRON)

⇒ difference in rapidity distributions between t and \bar{t} in pp collisions (LHC)

⇒ test of production mechanism

Intuitive picture

inclusive cross section

top and light quark in same direction
preferred coherence with gluon field!
 \Rightarrow positive asymmetry for
inclusive cross section

$t\bar{t}g$

probability for gluon emission enhanced
if t and q in opposite direction
 \Rightarrow negative asymmetry for $t\bar{t}g$
(tagged events)

semi inclusive cross section

cuts on gluon emission ($\hat{=} p_T$ of $t\bar{t}$)!
 \Rightarrow enhancement of asymmetry

II PARTONIC LEVEL

differential asymmetry
($q\bar{q}$ induced)

$$\begin{aligned} \hat{A}(\cos\hat{\Theta}) &= \frac{N_t(\cos\hat{\Theta}) - N_{\bar{t}}(\cos\hat{\Theta})}{N_t(\cos\hat{\Theta}) + N_{\bar{t}}(\cos\hat{\Theta})} \\ &= \frac{N_t(\cos\hat{\Theta}) - N_{\bar{t}}(-\cos\hat{\Theta})}{N_t(\cos\hat{\Theta}) + N_{\bar{t}}(-\cos\hat{\Theta})} \end{aligned}$$

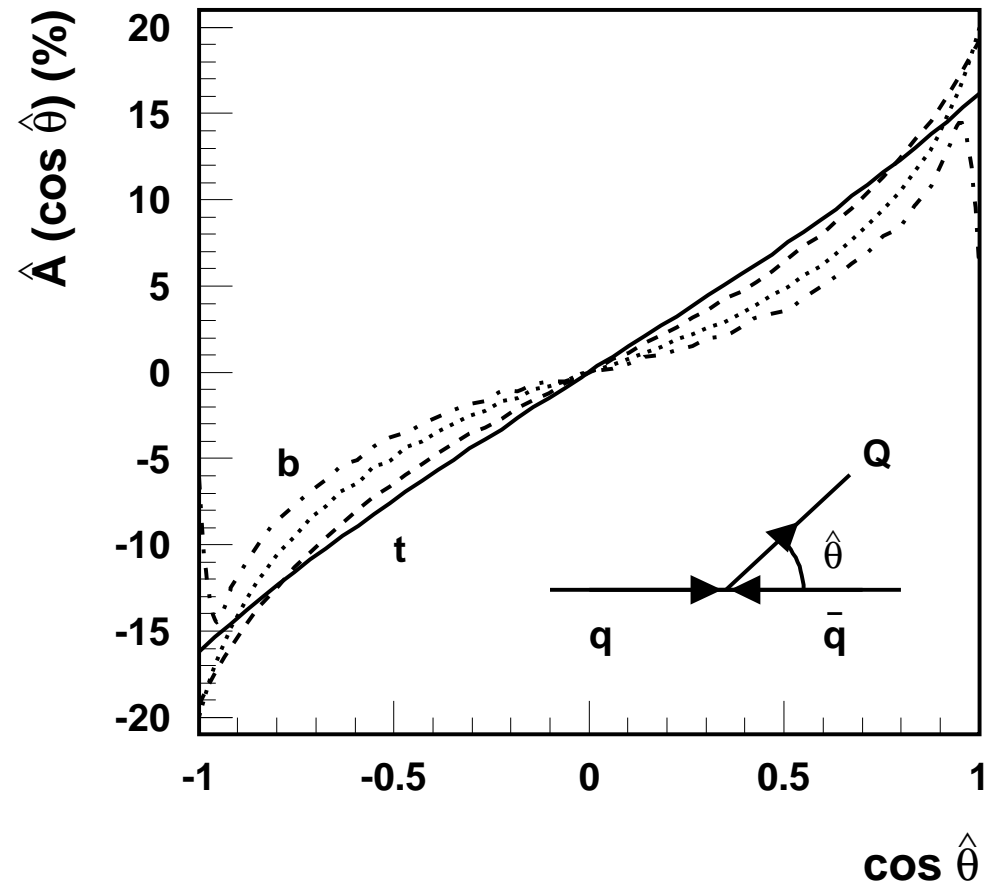

integrated asymmetry
(parton level)

as function of $\sqrt{\hat{s}}$:

$$\begin{aligned} & \hat{A}(\cos\hat{\Theta}) \\ &= \frac{N_t(\cos\hat{\Theta} \geq 0) - N_{\bar{t}}(\cos\hat{\Theta} \geq 0)}{N_t(\cos\hat{\Theta} \geq 0) + N_{\bar{t}}(\cos\hat{\Theta} \geq 0)} \\ &= \frac{N_t(\cos\hat{\Theta} \geq 0) - N_t(\cos\hat{\Theta} \leq 0)}{N_t(\cos\hat{\Theta} \geq 0) + N_t(\cos\hat{\Theta} \leq 0)} \end{aligned}$$

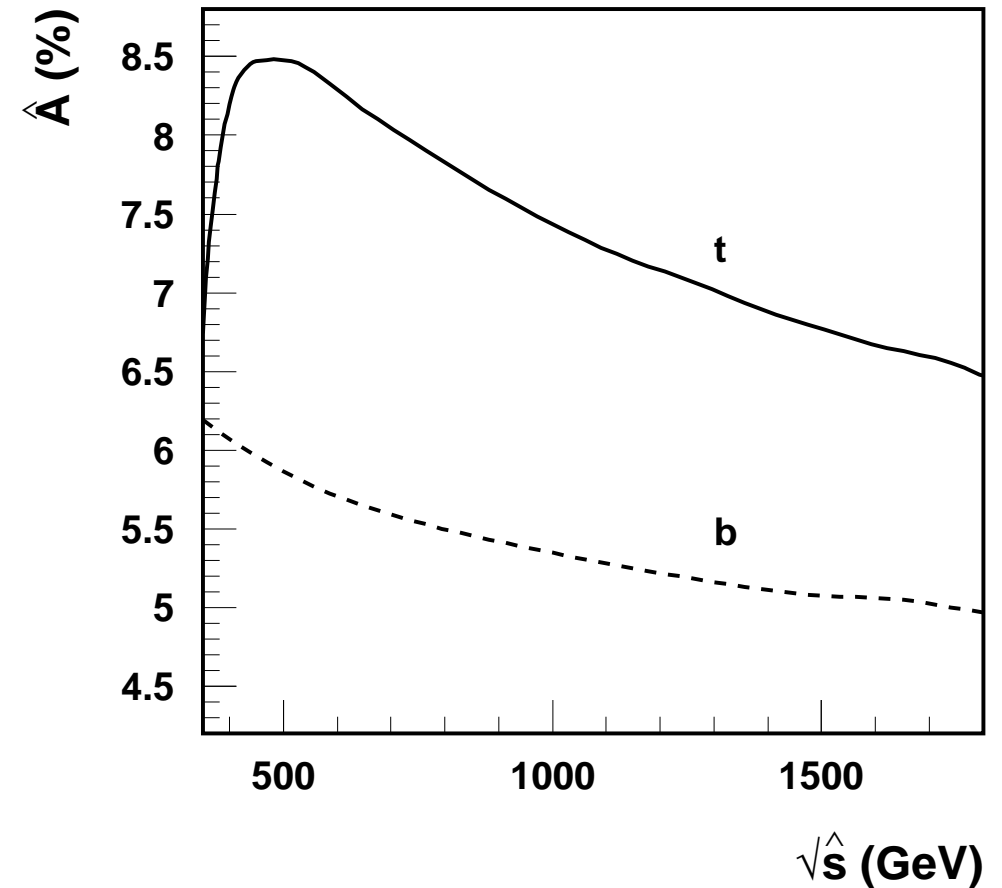

EW corrections (QED)

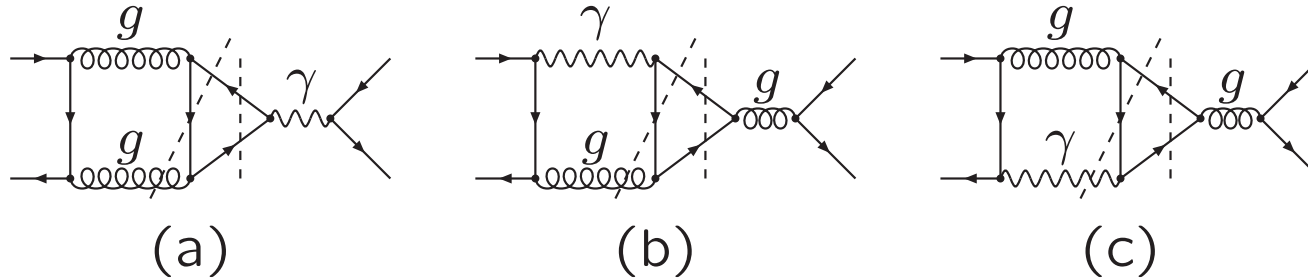

Relative factor between QCD and QED

$$f_q^{\text{QED}} = 3 \frac{\alpha_{\text{QED}} Q_t Q_q}{\frac{\alpha_S}{2} \left(\frac{d_{abc}^2}{4} \right)^2} = \frac{\alpha_{\text{QED}}}{\alpha_S} \frac{36}{5} Q_t Q_q$$

Assuming the ratio 4 : 1 (2 : 1 @LHC) for $u\bar{u} : d\bar{d}$ events

$$f^{\text{QED}} = \frac{4f_u^{\text{QED}} + f_d^{\text{QED}}}{5} \approx 0.18$$

$$f^{\text{QED}} = \frac{2f_u^{\text{QED}} + f_d^{\text{QED}}}{3} \approx 0.13$$

PDFs modify these ratios slightly, but do not change the predictions significantly.

EW corrections (weak)

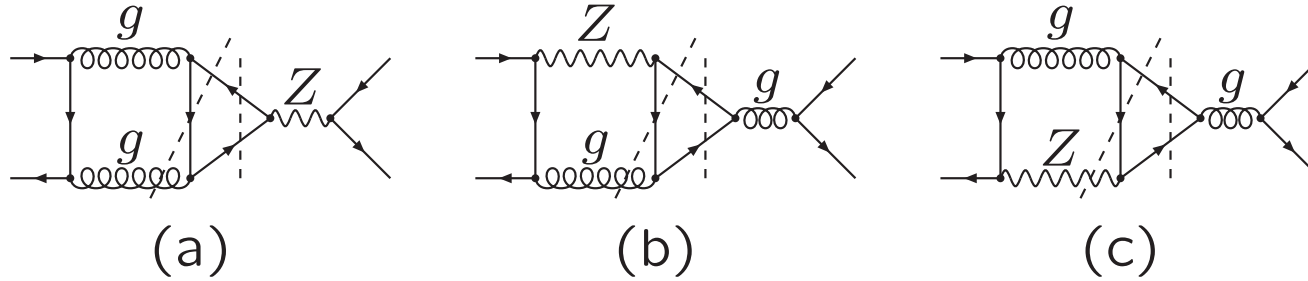

$$f^{\text{weak}} = 3 \frac{\alpha_{\text{QED}}}{\alpha_S} \frac{36}{5} \frac{1 - \frac{8}{3} s_W^2}{1 - m_Z^2/\hat{s}} \frac{1}{16 s_W^2 c_W^2} \frac{4(1 - \frac{8}{3} s_W^2) + (-1 + \frac{4}{3} s_W^2)}{5}$$

$$\approx 0.013(0.002 \text{ @ LHC})$$

▷ strong cancellation between up and down quark contributions

III HADRONIC COLLISIONS

$$p\bar{p} \quad - \quad 1.96 \text{ TeV}$$

dominantly central production:

$$q\bar{q} \rightarrow t\bar{t}$$

partonic asymmetry



hadronic asymmetry

⇒ Integrated asymmetry

$$A_{Lab} = \frac{N(y_t > 0) - N(y_{\bar{t}} > 0)}{N(y_t > 0) + N(y_{\bar{t}} > 0)} = 0.056(7)$$

charge asymmetry \equiv forward-backward asymmetry

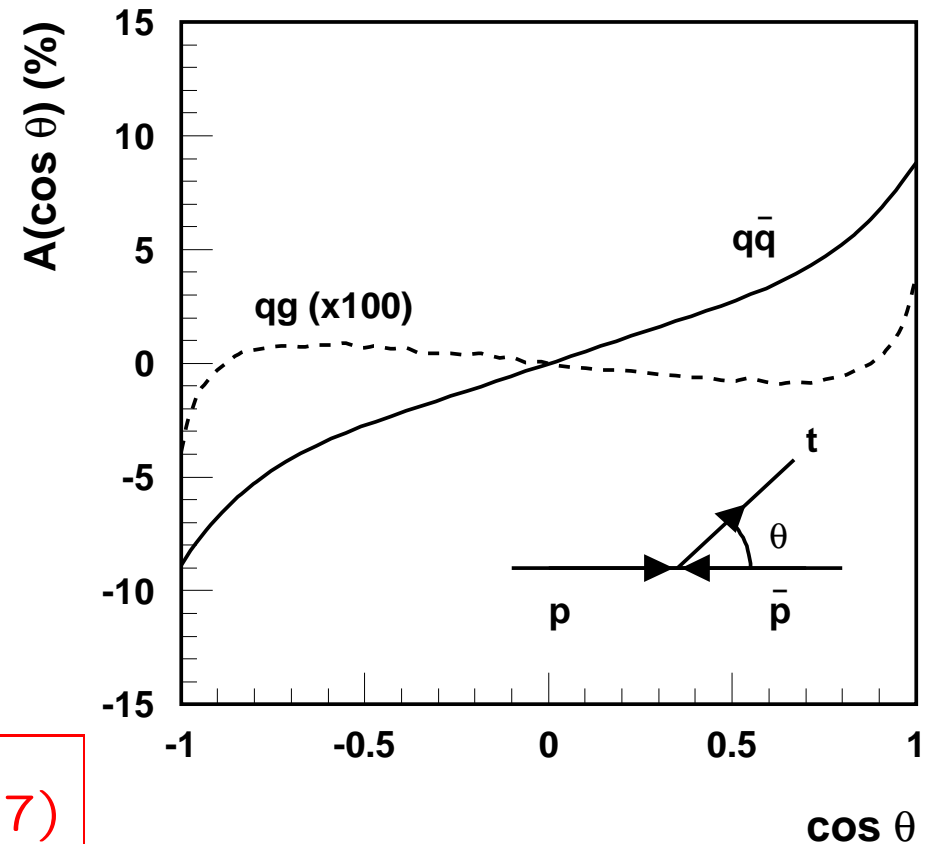

alternative:

$$A_{t\bar{t}} = \frac{N(\Delta y > 0) - N(\Delta y < 0)}{N(\Delta y > 0) + N(\Delta y < 0)} = 0.087(10)$$

$$\Delta y = y_t - y_{\bar{t}}$$

(asymmetry in $t\bar{t}$ restframe \approx partonic asymmetry)

- QCD-EW contribution \Rightarrow factor 1.2 (JK, Rodrigo/ Hollik, Pagani)
- leading order asymmetry normalized relative to leading order cross section
- stable against NLL and NNLO threshold resummations (Almeida,.../ Ahrens,...)
- large corrections for $t\bar{t}g$ (Dittmaier, Uwer, Weinzierl) waiting for full NLO of $A_{t\bar{t}}$

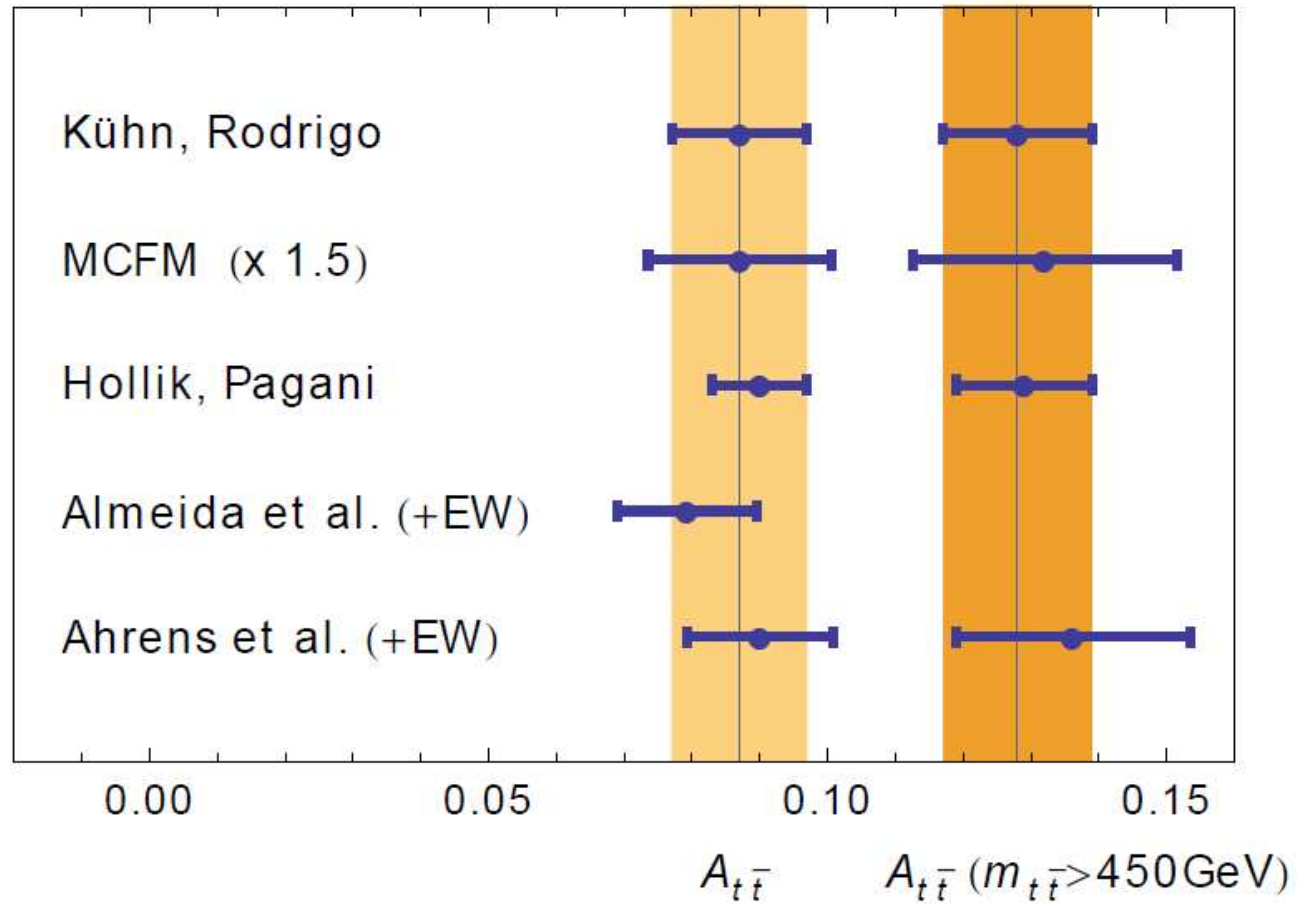

- ▷ Main difference due to renormalization scale choice, the asymmetry is proportional to the strong coupling
- ▷ small dependence on PDFs

Invariant mass dependent charge asymmetry

Since 2008, a systematic $1-2\sigma$ **positive** discrepancy with the SM (inclusive asymmetry)

CDF [PRD83 (2011)112003 arXiv:1101.0034] $t\bar{t}$ rest frame 5.3fb^{-1}

$$A_{t\bar{t}}(m_{t\bar{t}} < 450\text{GeV}) = -0.116 \pm 0.146(\text{stat}) \pm 0.047(\text{syst})$$

$$A_{t\bar{t}}(m_{t\bar{t}} > 450\text{GeV}) = 0.475 \pm 0.101(\text{stat}) \pm 0.049(\text{syst})$$

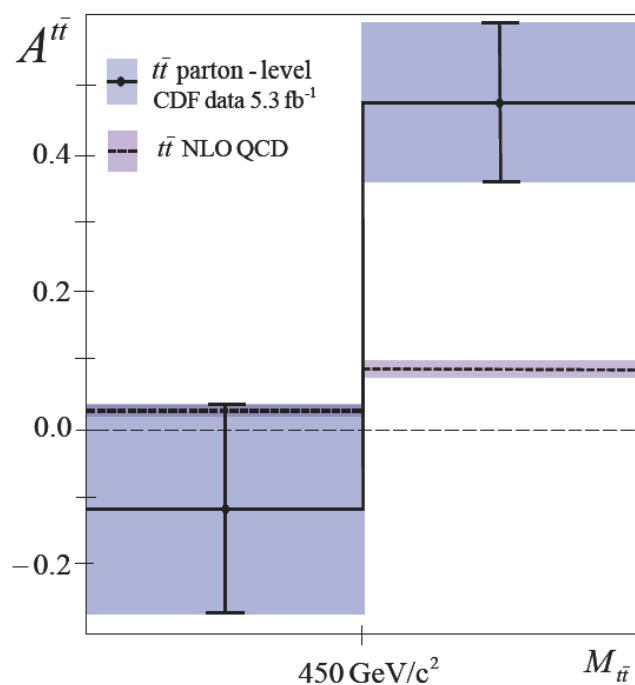

- **below 450 GeV:** negative asymmetry but still compatible with the SM within 1σ
- **above 450 GeV:** positive asymmetry disagrees with the SM at 3.4σ
- The deviation from the SM in the lab frame is not as significant!!!

Tevatron (and LHC) summary

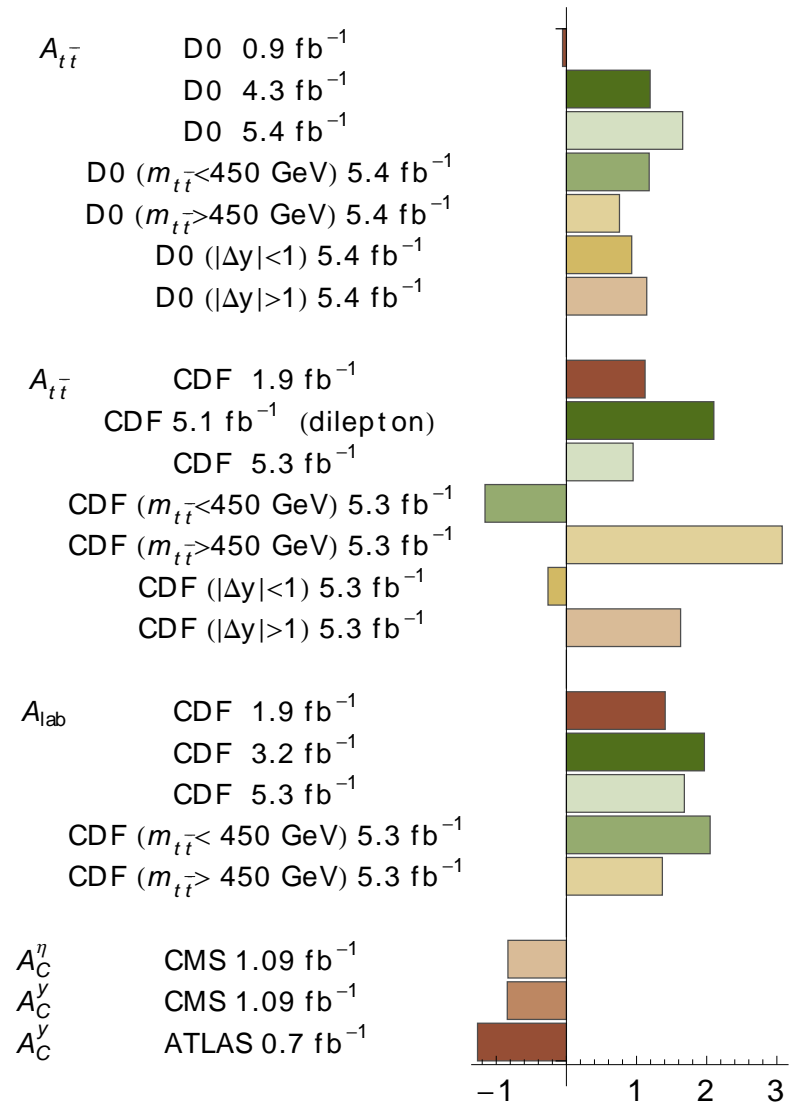

pp – 14 TeV

- no forward backward asymmetry
- slight difference between rapidity distributions of Q and \bar{Q} from (small) admixture of $q\bar{q}$ processes

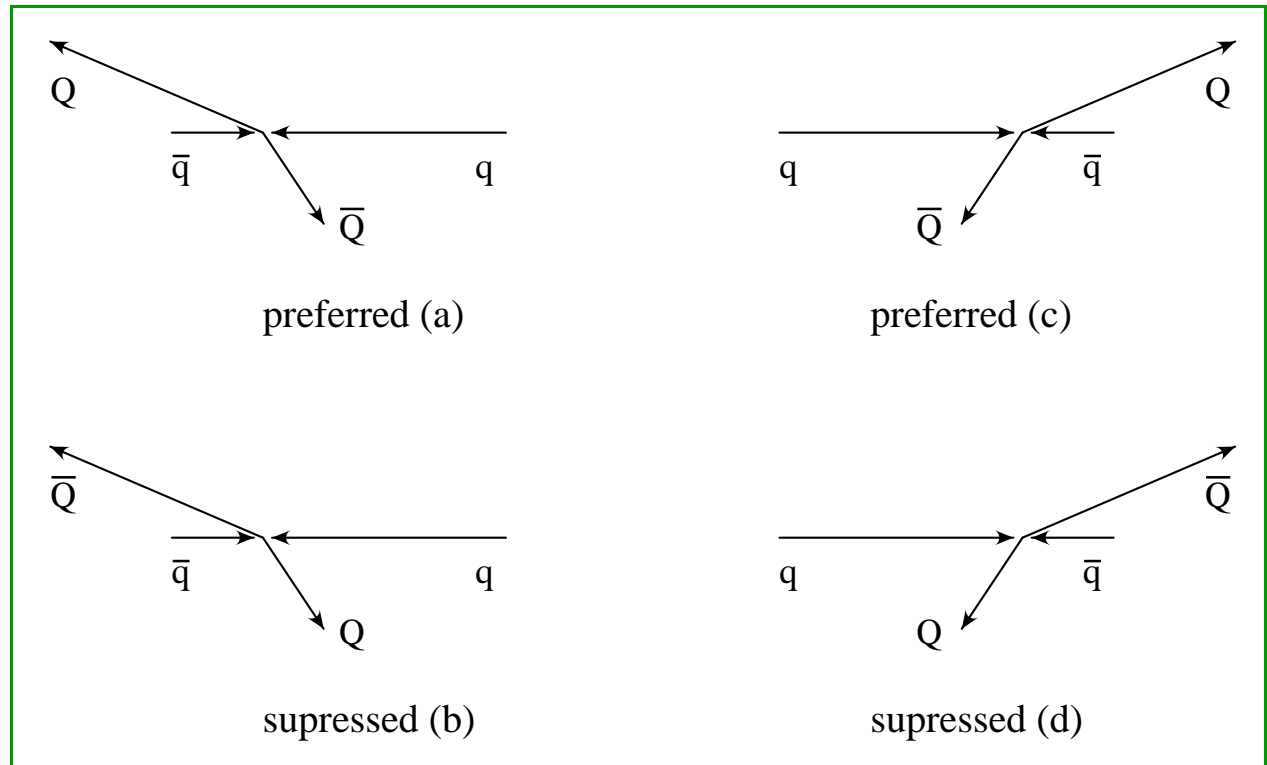

- ⇒ more t at large rapidity
- ⇒ more \bar{t} at small rapidity

main effect in regions of small cross section

JK, Rodrigo (1998)

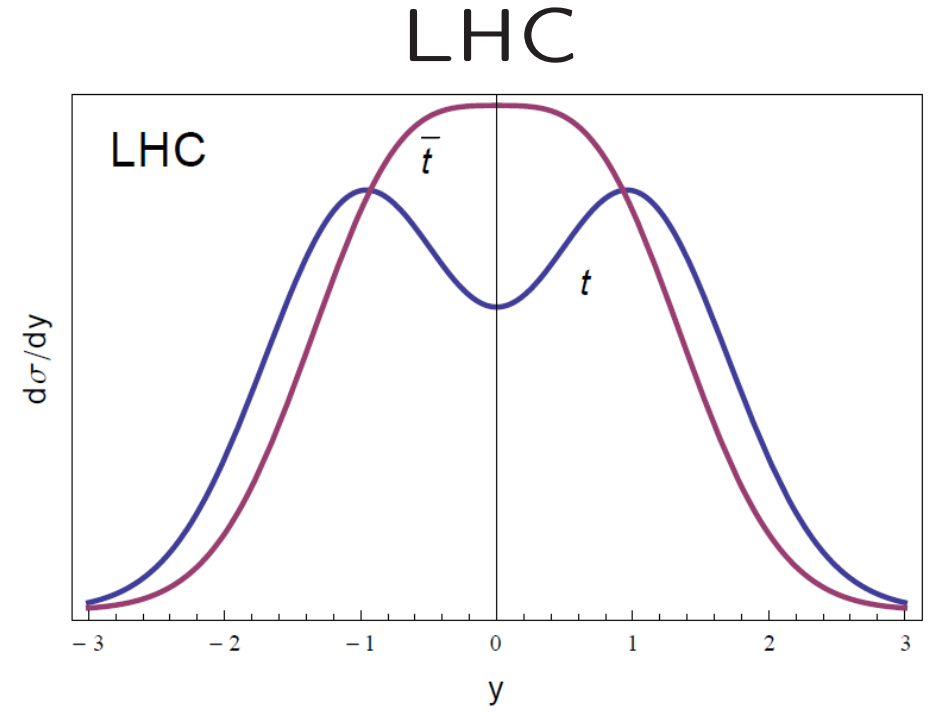
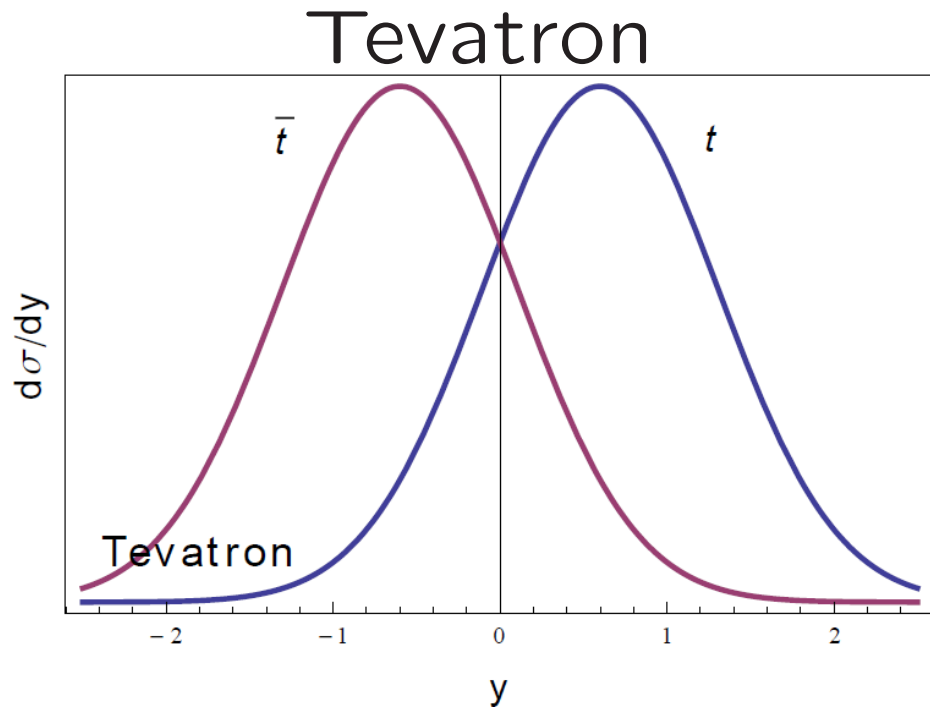

(qualitative picture, exaggerated scales)

Quantitative

$$A_{\text{LHC}}^{\Delta} \equiv \frac{N(\Delta > 0) - N(\Delta < 0)}{N(\Delta > 0) + N(\Delta < 0)};$$

$$\Delta = |y_t| - |y_{\bar{t}}| \text{ or } y_t^2 - y_{\bar{t}}^2$$

$$= 0.0115(6)$$

$$-0.024 \pm 0.016 \pm 0.023$$

$$-0.013 \pm 0.028 \begin{matrix} +0.029 \\ -0.031 \end{matrix}$$

$$0.004 \pm 0.010 \pm 0.012$$

JK, Rodrigo JHEP 1201(2012)063

atlas-conf-2011-106

cms (1112.5100)

cms-pas-top-11-030

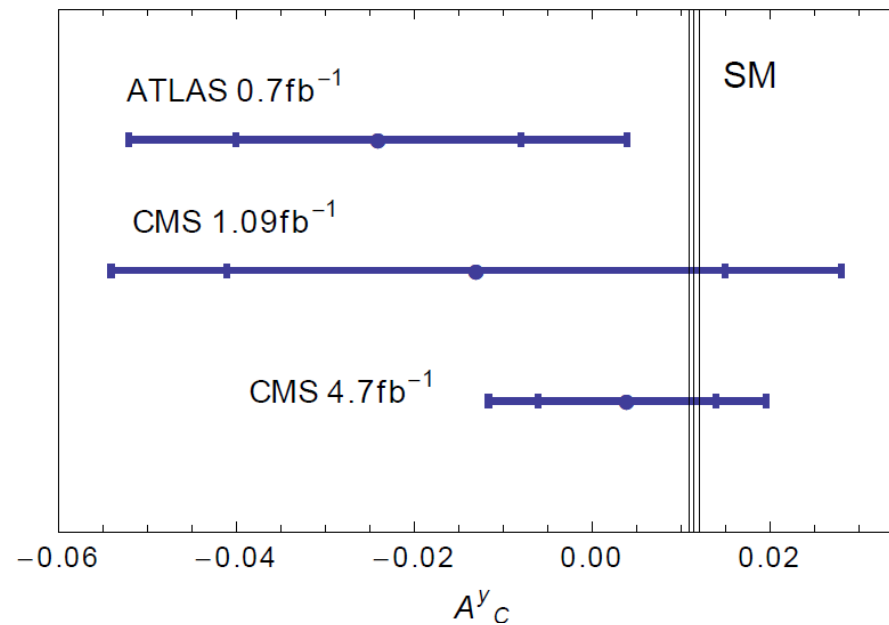

perspectives: $100\text{fb}^{-1} : \delta A \sim 2 - 3 \text{ permille}$

Cutoff-dependence:

cut on $p_{\perp}(t\bar{t}) = p_{\perp}(g)$ enhances asymmetry

consider $A_{t\bar{t}}(Y) = \frac{N(\Delta y > 0) - N(\Delta y < 0)}{N(\Delta y > 0) + N(\Delta y < 0)}$ for $Y = \frac{y_t + y_{\bar{t}}}{2}$ fixed and $\Delta y = y_t - y_{\bar{t}}$

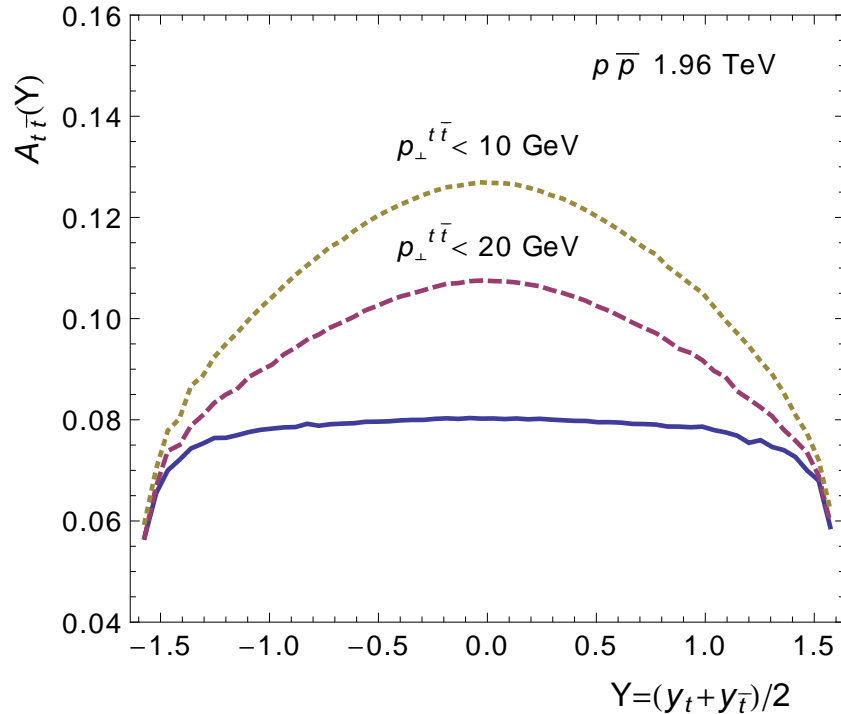

solid line: no cut on $p_{\perp}^{t\bar{t}}$,
dotted/dashed line: similar effects on
integrated asymmetry!

$p_{\perp}^{\max} = 10 \text{ GeV} / 20 \text{ GeV}$.

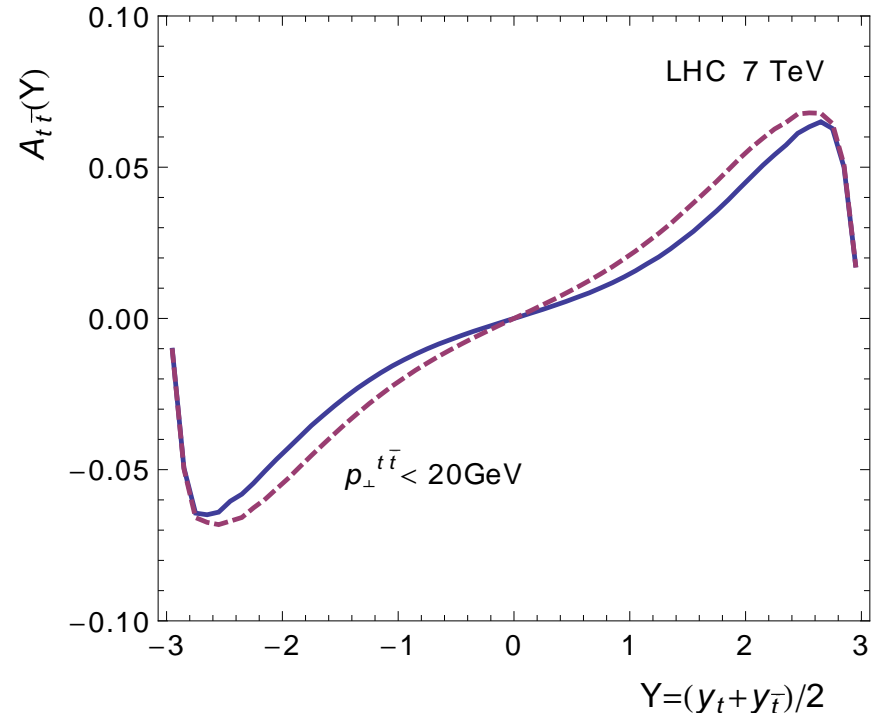

solid line: no cut on $p_{\perp}^{t\bar{t}}$,
dashed line: $p_{\perp}^{\max} = 20 \text{ GeV}$.

Summary

- ★ forward backward asymmetry for t production at TEVATRON $\sim 7\%$
- ★ important test of production mechanism
- ★ unique possibility for $p\bar{p}$ collider
- ★ differences between t and \bar{t} distributions at LHC mainly in regions of small cross section (large rapidity!)
- ★ Large statistics anticipated for LHC
- ★ strong sensitivity to cuts on p_T distribution